

LINEA/3 Strati

LINEA / 3 Layers

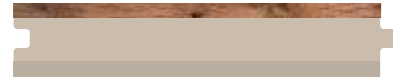

legno nobile 6 mm
 6 mm of hardwood



17 mm

6 mm di legno nobile e supporto in Abete doppio incrociato. Spazzolato, bisellato, verniciato all'acqua.
 6 mm of hardwood and fir double-crossed support. Brushed, bevelled, water lacquered

bistrato incrociato di abete
 fir double-crossed support

Il Parquet della collezione LINEA è in Quercia Francese e si compone di un elemento con un inserto in Ottone, Rame o Acciaio.
 LINEA is in French Oak and it is made up of one element with brass, copper or steel insert.

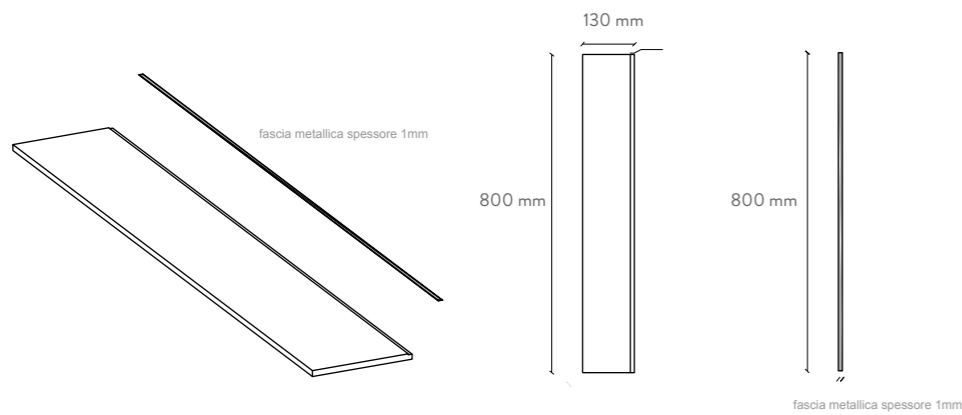

Listone 17x130x800 mm.
 con inserto in Ottone, Rame o Acciaio
 Plank 17x130x800 mm
 with brass, copper or steel insert.

Da abbinare a: Quercia Francese 3 strati con 6 mm di legno nobile e supporto in Abete doppio incrociato. Spazzolato, bisellato, verniciato all'acqua
 Listone 17x130x800 mm.
 To be combined with: 3-layer French oak with 6 mm of hardwood and fir double-crossed support. Brushed, bevelled, water lacquered.
 Plank 17x130x800 mm

OPZIONI/OPTIONS



Tinta a campione
 Sample colour



Spessore da 20 mm
 20 mm thickness

VERNICIATO/LACQUERED

La vernice che utilizziamo è all'acqua, a basse emissioni di sostanze organiche volatili (VOC).
 Essa crea una patina superficiale sul legno che ha la funzione di ricreare particolari effetti di colore, proteggendo la superficie.
 We use water paint with low emission of volatile organic compounds (VOC).
 The paint creates a patina on the wood that results in special color effects and protects the surface.



NATURALE



NATURA *



FERRO

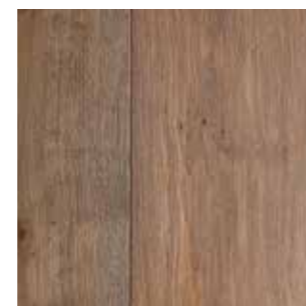

FANGO



ARGENTO



TABACCO

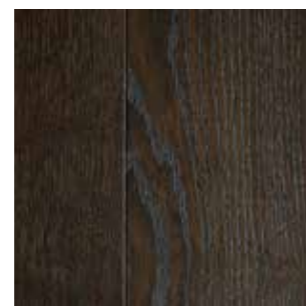

ARGILLA



CARBONE

* Disponibile anche ad OLIO NATURALE/ Also available natural oil finishing

SCHEMA DI POSA/LAYING DIAGRAMS

CASUALE/CASUAL

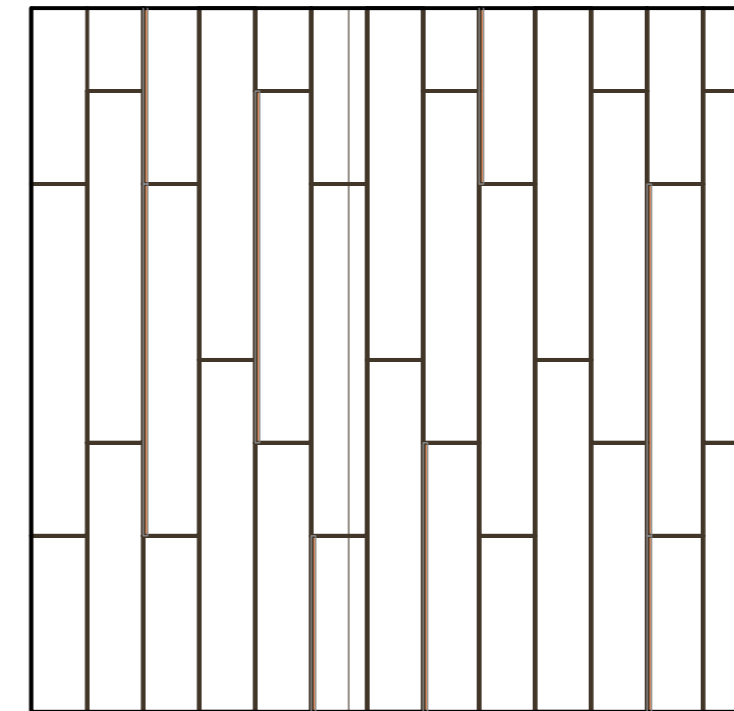

LINEA/LINE

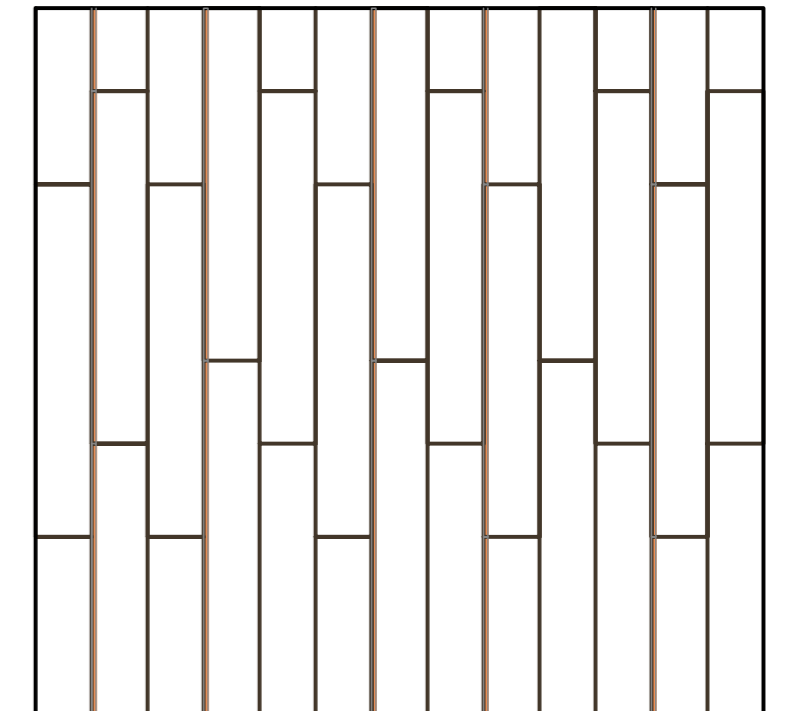

GEOMETRICO/GEOMETRIC

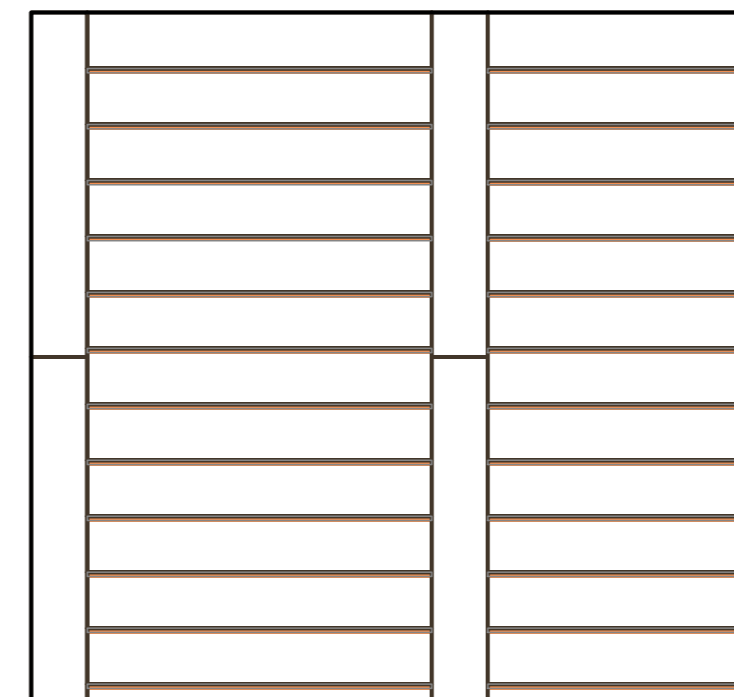

SPINA ITALIANA/ITALIAN HERRINGBONE

